

Anatomische pinzetten, chirurgische pinzetten

Pinces à dissection, pincettes à griffes

Pinzas de disección, pinzas de disección condientes

Pinze Anatomiche per dissezion, pinze chirurgiche a dentiditopo



- 04-101-10 10 cm
- 04-102-10 10.5 cm
- 04-103-11 11.5 cm
- 04-104-13 13 cm
- 04-105-14 14 cm
- 04-106-14 14.5 cm
- 04-107-15 15 cm
- 04-108-16 16 cm
- 04-109-18 18 cm
- 04-110-20 20 cm
- 04-111-23 23 cm
- 04-112-25 25 cm
- 04-113-30 30 cm
- 04-114-35 35 cm serrated



- 04-115-10 10 cm
- 04-116-10 10.5 cm
- 04-117-11 11.5 cm
- 04-118-13 13 cm
- 04-119-14 14 cm
- 04-120-14 14.5 cm
- 04-121-15 15 cm
- 04-122-16 16 cm
- 04-123-18 18 cm
- 04-124-20 20 cm
- 04-125-23 23 cm
- 04-126-25 25 cm
- 04-127-30 30 cm
- 04-128-35 35 cm serrated



- 04-129-10 10 cm
- 04-130-10 10.5 cm
- 04-131-11 11.5 cm
- 04-132-13 13 cm
- 04-133-14 14 cm
- 04-134-14 14.5 cm
- 04-135-15 15 cm
- 04-136-16 16 cm
- 04-137-18 18 cm
- 04-138-20 20 cm
- 04-139-23 23 cm
- 04-140-25 25 cm
- 04-141-30 30 cm
- 04-142-35 35 cm serrated Curved



- 04-143-10 10 cm
- 04-144-10 10.5 cm
- 04-145-11 11.5 cm
- 04-146-13 13 cm
- 04-147-14 14 cm
- 04-148-14 14.5 cm
- 04-149-15 15 cm
- 04-150-16 16 cm
- 04-151-18 18 cm
- 04-152-20 20 cm
- 04-153-23 23 cm
- 04-154-25 25 cm
- 04-155-30 30 cm
- 04-156-35 35 cm serrated

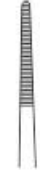

Dressing Forceps Standard

Dressing Forceps Delicate

Dressing Forceps Delicate Curved

Dressing Forceps Narrow Point serrated



- 04-157-10 10.5 cm
- 04-158-11 11.5 cm
- 04-159-13 13 cm
- 04-160-14 14.5 cm
- 04-161-16 16 cm
- 04-162-18 18 cm
- 04-163-20 20 cm
- 04-164-25 25 cm
- 04-165-30 30 cm



- 04-166-11 11.5cm
- 04-167-13 13cm
- 04-168-14 14.5cm
- 04-169-16 16cm
- 04-170-18 18 cm
- 04-171-20 20 cm
- 04-172-15 25 cm
- 04-173-30 30 cm 1x2 teeth



- 04-174-11 11.5cm
- 04-175-13 13cm
- 04-176-14 14.5cm
- 04-177-16 16cm
- 04-178-18 18 cm
- 04-179-20 20 cm 1x2 teeth



- 04-180-11 11.5cm
- 04-181-13 13cm
- 04-182-14 14.5cm
- 04-183-16 16cm
- 04-184-18 18 cm
- 04-185-20 20 cm
- 04-186-25 25 cm 1x2 teeth

Tissue Forceps Standard 1x2 Teeth

Tissue Forceps Delicate 1x2 Teeth

Tissue Forceps Delicate Curved 1x2 Teeth

Dissecting Forceps Narrow point 1x2 teeth

Anatomische pinzetten, chirurgische pinzetten

Pinces à dissection, pincettes à griffes

Pinzas de disección, pinzas de disección condientes

Pinze Anatomiche per dissezion, pinze chirurgiche a dentitidopo

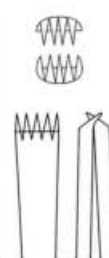

### Tissue Forceps 2x3 Teeth

04-187-11	11.5 cm
04-188-13	13 cm
04-189-14	14.5 cm
04-190-16	16 cm
04-191-18	18 cm
04-192-20	20 cm
04-193-25	25 cm
04-194-30	30 cm

### Tissue Forceps 3x4 Teeth

04-195-11	11.5 cm
04-196-13	13 cm
04-197-14	14.5 cm
04-198-16	16 cm
04-199-18	18 cm
04-200-20	20 cm
04-201-25	25 cm
04-202-30	30 cm

### Tissue Forceps 4x5 Teeth

04-203-11	11.5 cm
04-204-13	13 cm
04-205-14	14.5 cm
04-206-16	16 cm
04-207-18	18 cm
04-208-20	20 cm
04-209-25	25 cm
04-210-30	30 cm

### Beeson 04-211-16 16cm

### Treves Tissue Forceps 1x2 Teeth

04-212-12	12.5 cm
04-213-15	15 cm
04-214-18	18 cm



### Mod. USA, Tissue Forceps 1x2 teeth

04-215-10	10.5 cm
04-216-11	11.5 cm
04-217-12	12.5 cm
04-218-14	14 cm
04-219-16	16 cm
04-220-18	18 cm
04-221-20	20 cm
04-222-25	25 cm
04-223-30	30 cm

### Mod. USA, Dressing Forceps serrated

04-224-10	10.5 cm
04-225-11	11.5 cm
04-226-12	12.5 cm
04-227-14	14 cm
04-228-16	16 cm
04-229-18	18 cm
04-230-20	20 cm
04-231-25	25 cm
04-232-30	30 cm

### Standard Dressing Forceps wide pattern cross serration

04-233-11	11.5 cm
04-234-12	12.5 cm
04-235-14	14 cm
04-236-16	16 cm
04-237-18	18 cm
04-238-20	20 cm
04-239-25	25 cm
04-240-30	30 cm

### Dressing Forceps Serrated Angled

04-241-14	14 cm
04-242-16	16 cm
04-243-18	18 cm
04-244-20	20 cm

### Dressing Forceps Pointed, Plain

04-245-18	18 cm
04-246-20	20 cm





**Semken Dressing Forceps**  
04-247-12 12.5 cm  
04-248-15 15 cm  
straight serrated



**Semken Dressing Forceps**  
04-249-12 12.5 cm  
04-250-15 15 cm  
curved serrated

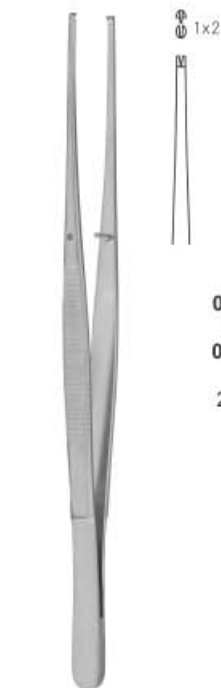

**Semken Tissue Forceps**  
04-251-12 12.5 cm  
04-252-15 15 cm  
1x2 teeth, straight

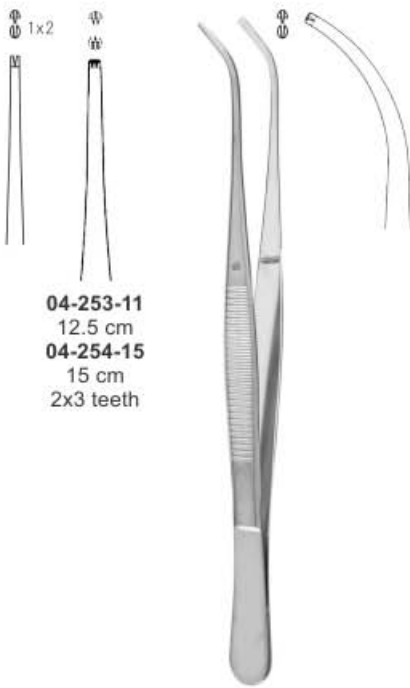

04-253-11  
12.5 cm  
04-254-15  
15 cm  
2x3 teeth



**Semken Tissue Forceps**  
04-255-12 12.5 cm  
04-256-15 15 cm  
1x2 teeth, curved



**Waugh Dressing Forceps**  
04-257-15 15 cm  
04-258-18 18 cm  
04-259-20 20 cm



**Waugh Tissue Forceps**  
1x2 Teeth  
04-260-15 15 cm  
04-261-18 18 cm  
04-262-20 20 cm



**Brophy Dressing Forceps**  
04-263-20 20 cm  
straight serrated



**Brophy Dressing Forceps**  
04-264-20 20 cm  
curved serrated



**Brophy Tissue Forceps**  
1x2 teeth  
04-265-20 20 cm  
straight serrated



**Brophy Tissue Forceps**  
1x2 teeth  
04-266-20 20 cm  
curved serrated



04-267-17 17.5 cm  
04-268-23 23 cm  
04-269-17 17.5 cm  
04-270-23 23 cm



**Gerald**  
1x2 teeth

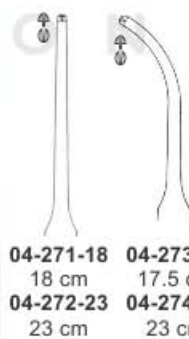

04-271-18 18 cm  
04-272-23 23 cm  
04-273-17 17.5 cm  
04-274-23 23 cm



**Potts-Smith Dressing Forceps**  
04-275-18 18 cm  
04-276-20 20 cm  
04-277-25 25 cm  
straight serrated



**Potts-Smith Dressing Forceps**  
04-278-18 18 cm  
04-279-20 20 cm  
04-280-25 25 cm  
curved serrated



**Potts-Smith Tissue Forceps 1x2 teeth**  
04-281-18 18 cm  
04-282-20 20 cm  
04-283-25 25 cm  
straight



**Potts-Smith Tissue Forceps 1x2 teeth**  
04-284-18 18 cm  
04-285-20 20 cm  
04-286-25 25 cm  
curved



**Cairns-Dott**  
04-287-18 18 cm  
04-288-22 22 cm



**Taylor Dressing Forceps**  
04-289-12 12 cm  
04-290-15 15 cm  
04-291-18 18 cm  
straight serrated



**Taylor Tissue Forceps**  
04-292-17 17 cm  
1x2 teeth, Straight



**Taylor Tissue Forceps**  
04-293-18 18 cm  
1x2 teeth, Curved



**Taylor**  
04-294-17 17 cm  
1x2 teeth



**Taylor**  
04-295-17 17 cm  
1x2 teeth



**Mc Indoe**  
04-296-15 15 cm  
1x2 teeth



**Cushing**

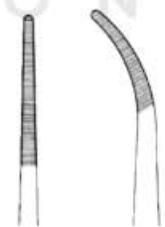

04-297-18 18 cm  
04-298-20 20 cm  
04-299-25 25 cm  
04-300-20 20 cm



**Cushing Dressing Forceps**  
04-301-17 17 cm  
Serrated Straight

**Cushing Dressing Forceps**  
04-302-18 18 cm  
Serrated Curved



**Cushing Tissue Forceps 1x2 teeth**  
04-303-20 20 cm  
Straight



**Cushing Tissue Forceps 1x2 teeth**  
04-304-18 18 cm  
Curved



**Gillies Tissue Forceps 1X2 Teeth**  
04-305-15 15 cm  
straight serrated



**Gillies Tissue Forceps 1X2 Teeth**  
04-306-15 15 cm  
curved serrated



**Strassburger Modell**  
5x6 teeth

04-307-15  
15 cm  
04-308-20  
20cm



**Jeans Dissecting Forceps Serrated Jaws**  
04-309-14 14cm  
04-310-18 18cm



**Jeans Dissecting Forceps 1x2 Teeth**  
04-311-14 14cm  
04-312-18 18cm



**Jeans Dissecting Forceps 2x3 Teeth**  
04-313-14 14cm  
04-314-18 18cm



Anatomische pinzetten, chirurgische pinzetten

Pinces à dissection, pincettes à griffes

Pinzas de disección, pinzas de disección condientes

Pinze Anatomiche per dissezion, pinze chirurgiche a dentitidopo



**Stille Dissecting Forceps**  
04-315-15 15 cm



**Stille-Barraya**



**04-316-18**  
18cm  
**04-317-20**  
20cm  
3x4 teeth



**04-318-25**  
25cm  
4x5 teeth



**Adlerkreutz Tissue Forceps with Serrated**



**04-319-15**  
15 cm  
**04-320-20**  
20 cm  
2x3 teeth



**04-321-15**  
15 cm  
4x5 teeth  
**04-322-20**  
20 cm  
4x5 teeth  
**04-323-25**  
25 cm  
4x5 teeth



**Lane Tissue Forceps**

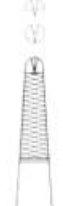

**04-324-12**  
12.5 cm  
1x2 teeth  
**04-325-15**  
15 cm  
1x2 teeth  
**04-326-17**  
17.5 cm  
1x2 teeth



**04-327-15**  
15 cm  
2x3 teeth  
**04-328-17**  
17.5 cm  
2x3 teeth



**Tissue Forceps**  
04-329-20  
20cm 1x2 teeth



**Stone Tissue Forceps**  
4X5 Teeth  
04-330-15 15 cm



**Lerche Tissue Forceps**  
5X6 Teeth  
04-331-15 15 cm



**Nelson Tissue Forceps**  
04-332-23 23 cm  
6x7 Teeth



**Tissue**  
6:7 Teeth



**Ferris-Smith Tissue Forceps 1x2 Teeth**  
04-333-12 12 cm  
04-334-14 14 cm  
04-335-16 16 cm  
04-336-18 18 cm  
04-337-20 20 cm



**Ferris-Smith Tissue Forceps 2x3 Teeth**  
04-338-12 12 cm  
04-339-14 14 cm  
04-340-16 16 cm  
04-341-18 18 cm  
04-342-20 20 cm

Anatomische pinzetten, chirurgische pinzetten

Pinces à dissection, pincettes à griffes

Pinzas de disección, pinzas de disección condientes

Pinze Anatomiche per dissezion, pinze chirurgiche a dentiditopo



**Bonney**  
04-343-17  
17 cm



**Bonney Tissue Forceps**



**04-344-18**  
18 cm  
1x2 Teeth

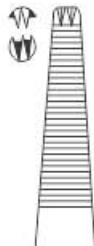
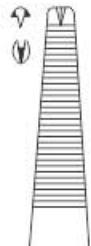

**04-345-18**  
18 cm  
2x3 Teeth



**Ramsay Dissecting Forceps**  
04-346-18 18 cm  
serrated jaws.



**Ramsay Tissue Forceps**  
1x2 Teeth  
04-347-18 18 cm  
Dissecting Forceps  
one into teeth on  
serrated jaws.



**Brown**  
04-348-15  
15 cm  
04-349-20  
20 cm



**Duehrssen Dressing Forceps**  
04-350-20 20 cm  
Serrated



**Duehrssen Tissue Forceps 1x2 Teeth**  
04-351-20 20 cm



**Duehrssen Tissue Forceps 2x3 Teeth**  
04-352-20 20 cm



**Charnley**  
04-353-14 14.5 cm  
04-354-18 18 cm  
block on jaws.  
1x2 teeth



**Dissecting Dressing Forceps**  
04-355-12 12.5 cm  
04-356-15 15 cm  
04-357-18 18 cm



**Dissecting Dressing Forceps**  
04-358-12 12.5 cm  
04-359-15 15 cm  
04-360-18 18 cm  
04-361-20 20 cm  
block end, serrated  
jaws.



Anatomische pinzetten, chirurgische pinzetten

Pinces à dissection, pincers à griffes

Pinzas de disección, pinzas de disección condientes

Pinze Anatomiche per dissezion, pinze chirurgiche a dentiditopo



**Wangenstein Dressing Forceps**  
04-362-23 23 cm



**Russian-Modell Tissue Forceps**  
04-363-15 15 cm  
04-364-20 20 cm  
04-365-25 25 cm

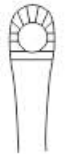

Grasping, Serrated



**Durante Tissue Grasping Forceps**  
04-366-14 14.5cm  
04-367-16 16 cm  
04-368-20 20 cm



**Selman**  
04-369-20 20 cm



Ø 4 mm



**Tuttle**



**04-370-23**  
23 cm



**04-371-30**  
30 cm

**KUMMAS**  
CORPORATION



**Singley-Tuttle Forceps**  
04-372-23 23 cm



**Collin-Duval Forceps**  
20cm

Grasping Forceps



14mm  
**04-373-14**



18mm  
**04-374-18**



27mm  
**04-375-27**



**Duval**  
14,5cm



**04-376-07**  
#1-7mm



**04-377-10**  
#2-10mm



**Ochsner**



**Ligature Forceps**  
**04-378-14**  
14.5 cm



2 mm

**Cooley Atraumatic Dressing Forceps**  
 04-379-15 15cm  
 04-380-20 20cm  
 04-381-24 24cm  
 04-382-30 30cm



2.7 mm

**Debakey Atraumatic Dressing Forceps**  
 04-383-15 15cm  
 04-384-20 20cm  
 04-385-24 24cm  
 04-386-30 30cm



3.5 mm

**Debakey Atraumatic Dressing Forceps**  
 04-387-15 15cm  
 04-388-20 20cm  
 04-389-24 24cm  
 04-390-30 30cm

1.2 mm



04-391-18 18 cm  
 04-392-21 21 cm

2 mm



04-393-18 18 cm  
 04-394-21 21 cm



**Debakey Dressing Forceps**



1.5 mm

04-395-12 12.5 cm  
 04-396-14 14.5 cm  
 04-397-16 16 cm  
 04-398-20 20 cm  
 04-399-24 24 cm

**Debakey Forceps**

2.0 mm



04-400-12 12.5 cm  
 04-401-14 14.5 cm  
 04-402-16 16 cm  
 04-403-20 20 cm  
 04-404-24 24 cm  
 04-405-30 30 cm

3.5 mm



04-410-16 16 cm  
 04-411-20 20 cm  
 04-412-24 24 cm  
 04-413-30 30 cm  
 04-414-35 35 cm



**De Bakey Forceps**



2 mm

04-415-16 16 cm Angular

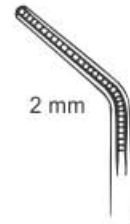

2 mm

04-416-20 20 cm Angular

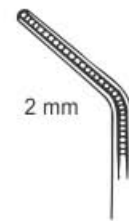

2 mm

04-417-24 24 cm Angular

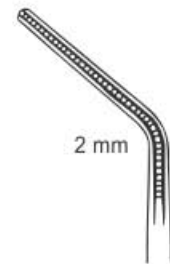

2 mm

04-418-30 30 cm Angular



**Adson**  
04-419-12 12 cm  
04-420-15 15 cm



**Micro-Adson**  
04-421-12 12 cm  
04-422-13 13 cm  
04-423-15 15 cm



**Adson**  
1x2 teeth  
04-424-12 12 cm  
04-425-15 15 cm  
04-426-18 18 cm  
04-427-20 20 cm



**Micro-Adson**  
1x2 teeth  
04-428-12 12 cm  
04-429-15 15 cm  
04-430-18 18 cm  
04-431-20 20 cm



**Adson**  
2x3 teeth  
04-432-12 12 cm  
04-433-15 15 cm  
04-434-18 18 cm  
04-435-20 20 cm



**Adson Serrated**  
1x2 teeth  
04-436-12 12 cm  
04-437-15 15 cm  
04-438-18 18 cm  
04-439-20 20 cm



**Adson-Brown**  
04-440-12 12 cm  
Straight



**Adson-Brown**  
04-441-12 12 cm  
Curved



**Adson-Graefe**  
04-442-12 12 cm



**Hudson**  
04-443-12 12 cm  
04-444-15 15 cm  
1x2 teeth



**Thorpe**  
Corneal Forceps  
04-445-12 12 cm





**Adson Tissue Forceps**  
Cutter Print



**04-446-01** regular point straight  
**04-447-02** fine point straight  
**04-448-03** micro point straight  
 12 cm 1x2 Teeth



**04-449-01** regular point with platform straight  
**04-450-02** fine point with platform straight  
**04-451-03** micro point with platform straight  
 12 cm 1x2 Teeth



**04-452-01** regular point curved  
**04-453-02** fine point curved  
**04-454-03** micro point curved  
 12 cm 1x2 Teeth



**04-455-01** regular point straight  
**04-456-02** fine point straight  
**04-457-03** micro point straight  
 12 cm 1x2 Teeth



**Adson Brown Tissue**



regular point, straight  
**04-458-12** 12 cm 9x9 teeth  
**04-459-15** 15 cm 9x9 teeth  
**04-460-20** 20 cm 9x9 teeth  
 fine point, straight  
**04-461-12** 12 cm 9x9 teeth  
**04-462-15** 15 cm 9x9 teeth  
**04-463-20** 20 cm 9x9 teeth



regular point, Curved  
**04-464-12** 12 cm 9x9 teeth  
**04-465-15** 15 cm 9x9 teeth  
**04-466-20** 20 cm 9x9 teeth  
 fine point, Curved  
**04-467-12** 12 cm 9x9 teeth  
**04-468-15** 15 cm 9x9 teeth  
**04-469-20** 20 cm 9x9 teeth



**Adson Tissue Forceps**  
with fenestrated handle



**04-470-01** regular point straight  
**04-471-02** fine point straight  
**04-472-03** micro point straight  
 12 cm 1x2 Teeth



**04-473-01** regular point with platform straight  
**04-474-02** fine point with platform straight  
**04-475-03** micro point with platform straight  
 12 cm 1x2 Teeth



**04-476-01** regular point curved  
**04-477-02** fine point curved  
**04-478-03** micro point curved  
 12 cm 1x2 Teeth



**04-479-01** regular point curved  
**04-480-02** fine point curved  
**04-481-03** micro point curved  
 12 cm 1x2 Teeth



**Adson Brown Tissue Forceps**  
Fenestrated Handle



**04-482-01** regular point, straight  
**04-483-02** fine point, straight  
 12 cm 7x7 teeth



**04-484-01** regular point, Curved  
**04-485-02** fine point, Curved  
 12 cm 7x7 teeth



**04-486-14**  
14 cm  
Dressing, Serrated  
**04-487-16**  
16 cm  
Dressing, Serrated  
**04-488-18**  
18 cm  
Dressing, Serrated  
**04-489-20**  
20 cm  
Dressing, Serrated

Lucae



1x2 teeth  
**04-490-14**  
14 cm  
**04-491-16**  
16 cm  
**04-492-18**  
18 cm  
**04-493-20**  
20 cm

Lucae



**Gruenwald Forceps**  
**04-494-14** 14 cm  
**04-495-16** 16 cm  
**04-496-20** 20 cm



**Gruenwald Tissue Forceps**  
**04-497-16** 16 cm  
**04-498-20** 20 cm



**Jansen**  
**04-499-16** 16 cm  
**04-500-18** 18 cm  
**04-501-20** 20 cm



**Adson Bayonet Dressing Forceps**  
**04-502-21** 21 cm  
serrated



**Plain Forceps**  
**04-503-18**  
18.5 cm



**Plain Forceps**  
**04-504-16**  
16 cm



**Tissue Forceps**  
**04-505-16**  
16 cm



**Hoen**  
**04-506-20**  
20 cm



**D'Errico**  
**04-507-22**  
22 cm



**D'Errico**  
**04-508-22**  
22 cm



**Wilde**  
04-509-11 11cm

**Wilde**  
04-510-13 13cm

**Troeltsch**  
04-511-10 10 cm  
04-512-13 13 cm

**Troeltsch**  
04-513-15 15 cm  
04-514-17 17 cm

**Troeltsch**  
04-515-13 13 cm

**KUMMAS**  
CORPORATION



**Wilde**  
04-516-10 10 cm  
04-517-11 11 cm

**Troeltsch**  
04-518-13 13 cm

**Landolt**  
04-519-21 21.5 cm

**Yasargil**  
04-520-20 20 cm

**Hunt**  
04-521-20 20 cm

**Adson**  
04-522-23 23 cm

**Hunt**  
04-523-20 20 cm





## SPLINTER FORCEPS

Splitterpinzetten | Pincas à écharde  
Pinzas Para espinas | Pinze per scheggie



04-540-07  
7.5 cm  
04-541-09  
9 cm  
04-542-11  
11.5 cm  
Straight

Feilchenfeld Forceps



Feilchenfeld



04-543-75  
7.5 cm



04-544-95  
9.5 cm



04-545-11  
11.5 cm



Hunter Forceps



04-546-10  
10.5 cm  
Straight



Hunter Forceps



04-547-10  
10.5 cm  
Curved



Carmalt Forceps



04-548-10  
10.5 cm  
Straight



Carmalt Forceps



04-549-10  
10.5 cm  
Curved



Michel clip applying forceps  
04-550-12 12 cm



Shaaf  
Splinter Forceps



04-551-09  
9.5 cm



**Splinter Forceps**  
04-552-08 8 cm  
04-553-09 9 cm  
04-554-10 10.5 cm  
04-555-11 11.5 cm  
04-556-12 12 cm  
04-557-14 14.5 cm  
Straight serrated with  
guide pin



**Splinter Forceps**  
04-558-08 8 cm  
04-559-09 9 cm  
04-560-10 10.5 cm  
04-561-11 11.5 cm  
04-562-12 12 cm  
04-563-14 14.5 cm  
Curved serrated with  
guide pin



**Splinter Forceps**  
04-564-08 8 cm  
04-565-09 9 cm  
04-566-10 10.5 cm  
04-567-11 11.5 cm  
04-568-12 12 cm  
04-569-14 14.5 cm  
Straight plain with  
guide pin



**Splinter Forceps**  
04-570-08 8 cm  
04-571-09 9 cm  
04-572-10 10.5 cm  
04-573-11 11.5 cm  
04-574-12 12 cm  
04-575-14 14.5 cm  
Curved plain with  
guide pin



**Stieglitz Forceps  
with Magnifying  
Mirrors**  
04-576-12  
12.5 cm

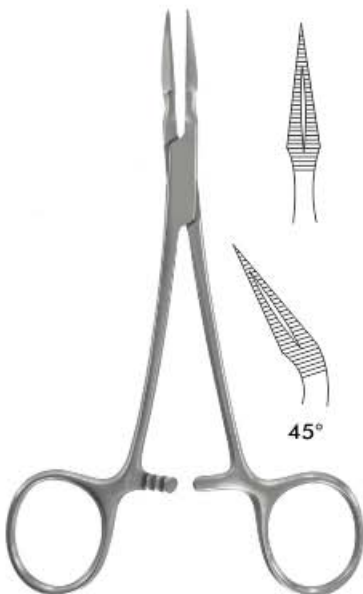

**Stieglitz Splinter Forceps**  
04-577-14 14 cm Straight  
04-578-14 14 cm 45° Angled

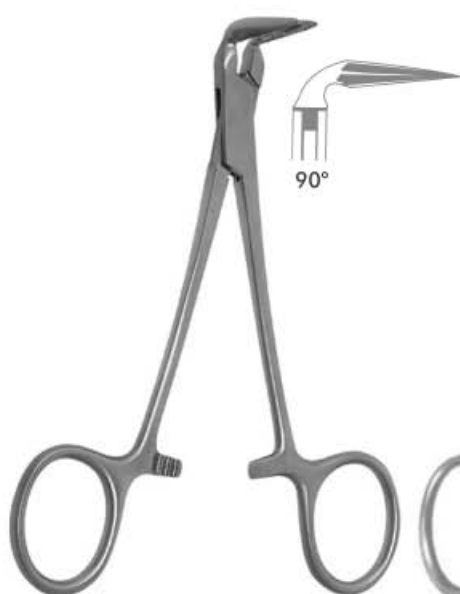

**Stieglitz Splinter Forceps**  
04-579-14  
14 cm 90° Angled



**Peet Splinter Forceps**  
04-580-11  
11.5 cm

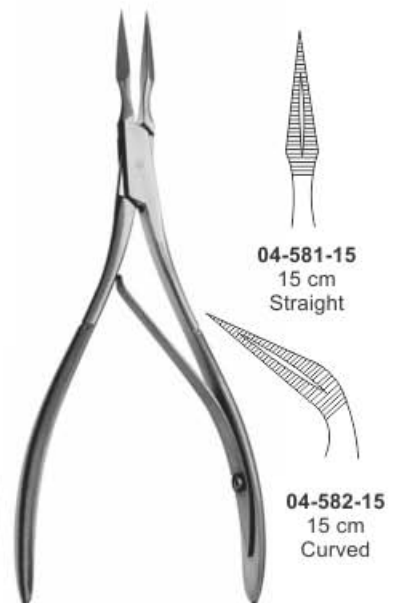

**Ralk Splinter Forceps**

04-581-15  
15 cm  
Straight

04-582-15  
15 cm  
Curved





**Dumont Forceps**  
04-583-11 11.5 cm  
curved



**04-584-01**  
10.5 cm  
full curved



**04-585-02**  
10.5 cm  
half curved



**04-586-03**  
11 cm



**04-587-04**  
11 cm  
fine point



**04-588-05**  
11 cm  
extra fine point



**04-589-06**  
12 cm  
fine point



**04-590-07**  
12 cm  
extra fine point



**04-591-08**  
12 cm



**Dumont Forceps**  
04-592-01  
style 1, fine point,  
12 cm



**Dumont Forceps**  
04-593-02  
style 2, strong  
fine point,  
12 cm



**Dumont Forceps**  
04-594-03  
style 3, narrow  
fine point,  
12 cm



**Dumont Forceps**  
04-595-31  
style 3C, narrow  
fine point,  
11 cm



**Dumont Forceps**  
04-596-04  
style 4, fine point,  
11cm



**Dumont Forceps**  
04-597-05  
style 5, super fine  
11cm point



**Dumont Forceps**  
**04-598-51**  
 style 5, micro fine  
 11cm point



**Dumont Forceps**  
**04-599-06**  
 style 6, pick up,  
 11.5 cm



**Dumont Forceps**  
**04-600-07**  
 style 7, fine curved,  
 11.5 cm



**Dumont Forceps**  
**04-601-71**  
 style 7, micro fine  
 11.5 cm curved



**Jeweler Forceps**  
**04-602-12**  
 12.8cm



**Jeweler Forceps**  
**04-603-14**  
 14.2cm



**Microscopic Forceps**  
**04-604-10**  
 10 cm



**Microscopic Forceps**  
 super light, blunt  
**04-605-10**  
 10 cm



**Paper Dressing Forceps**  
**04-606-15** 15 cm



**04-607-15**  
 15 cm



**Paper Dressing Forceps**  
**04-608-15**

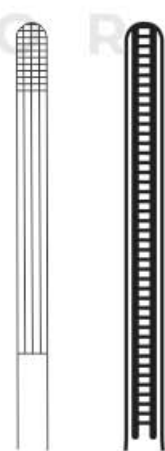

**04-608-15**  
 Debakey



**Miller Articulating Paper Forceps**  
**04-609-15**  
 Curved 15 cm



**Paper Dressing Forceps**  
**04-610-15** 15 cm  
 Curved

## CILIA FORCEPS

Cilienpinzetten  
Pinzas depilatorias

Pinces à épiler les cils  
Pinze depilatoria



**Ziegler Cilia Forceps**  
04-611-09 9 cm



**Douglas Cilia Forceps**  
04-612-09 9 cm



**Douglas Cilia Forceps**  
04-613-09 9 cm



**Beer Cilia Forceps**  
04-614-09 9 cm



**Gradle Cilia Forceps**  
04-615-10 10.5cm



**Kuehne Cilia Forceps**  
04-616-10 10.5cm



**Kuehne Cilia Forceps**  
04-617-10 10.5cm  
angled sideways



**Barraquer Cilia Forceps**  
04-618-10 10.5cm



**Littauer Cilia Forceps**  
04-619-08 8.5 cm



**Littauer Cilia Forceps**  
04-620-09 9 cm



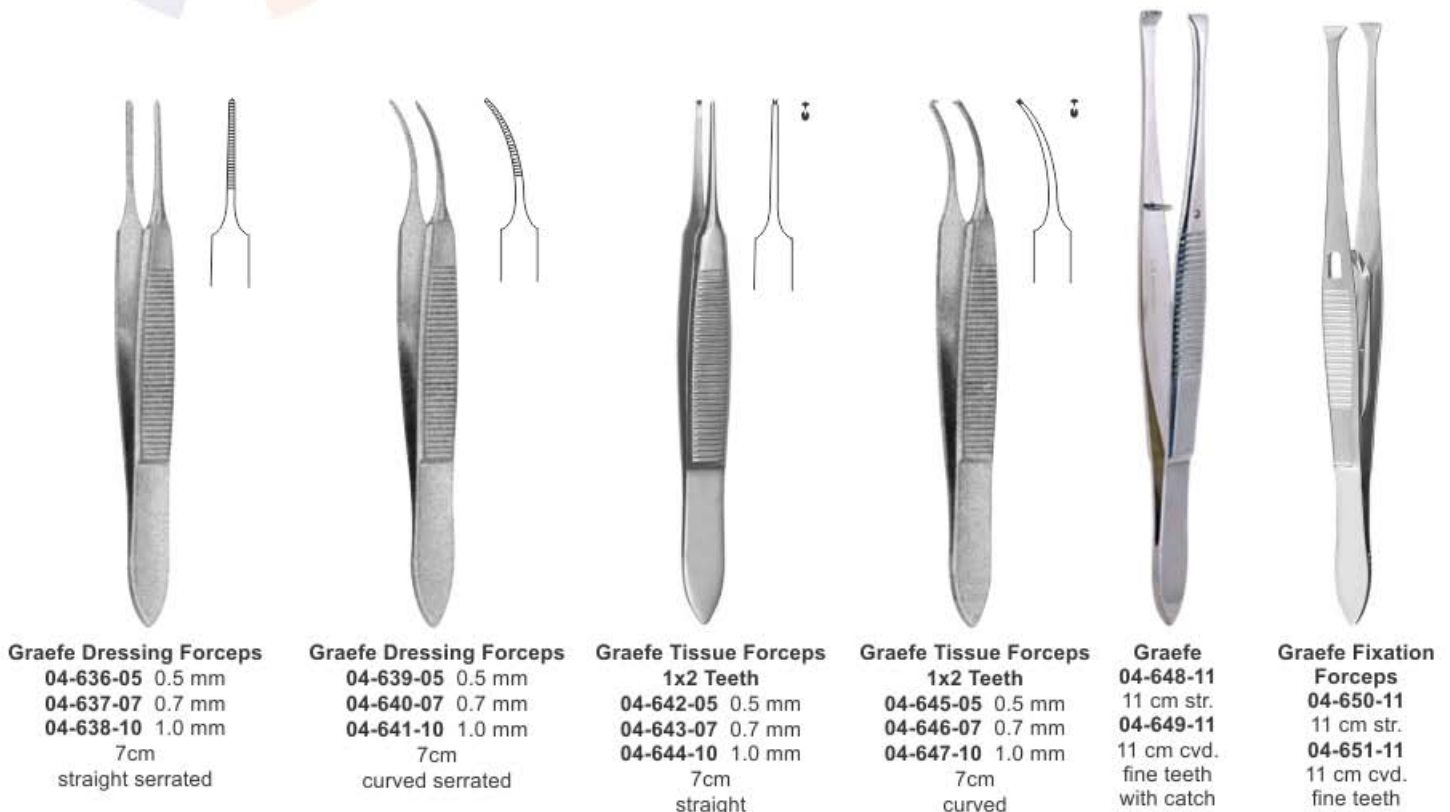

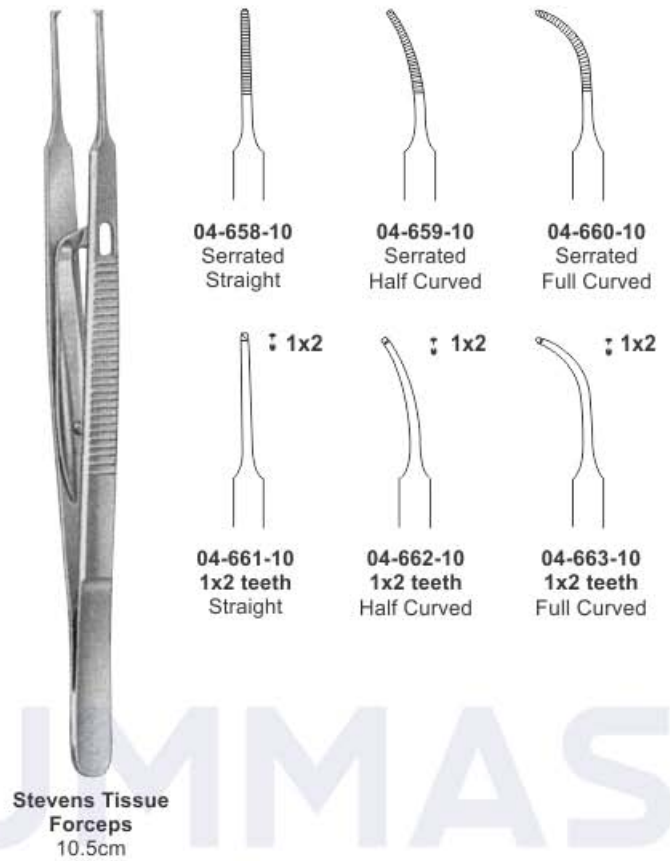
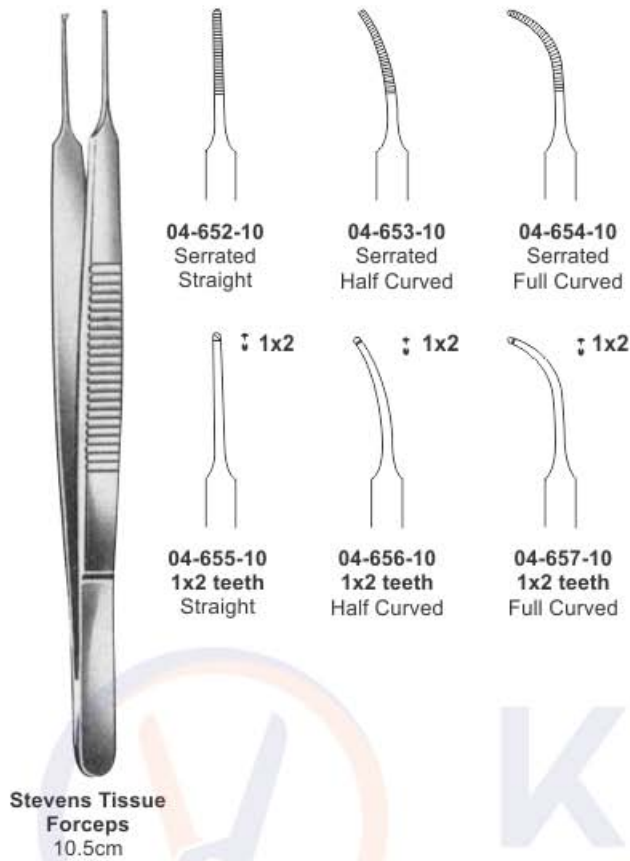

KUMMAS  
CORPORATION

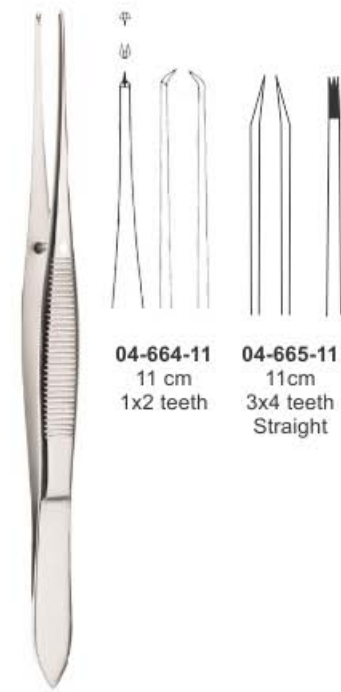

Elschnig

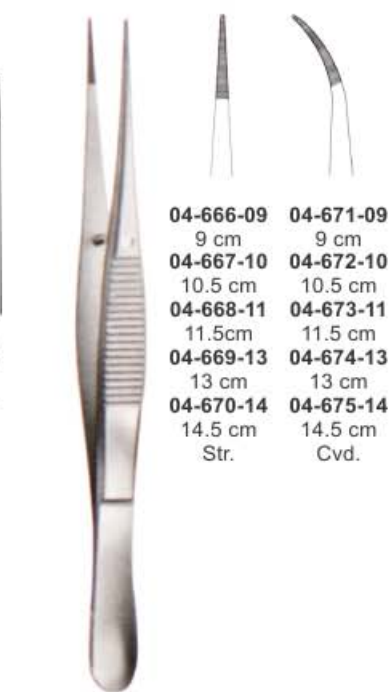

Moorfield Forceps

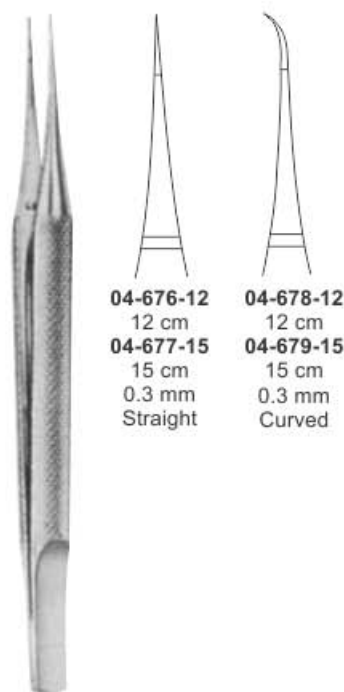

Micro Forceps  
Smooth Jaw

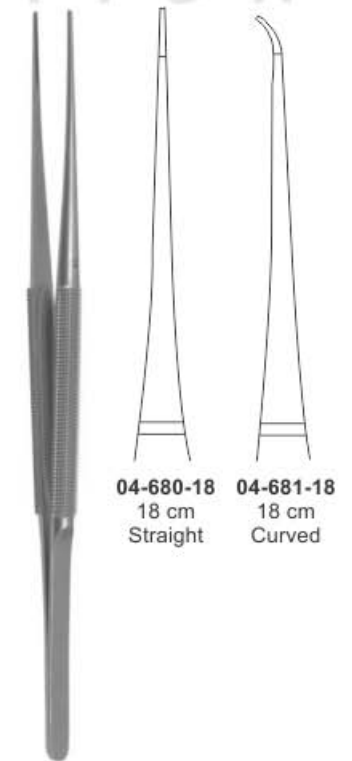

Micro Forceps  
Smooth Jaw

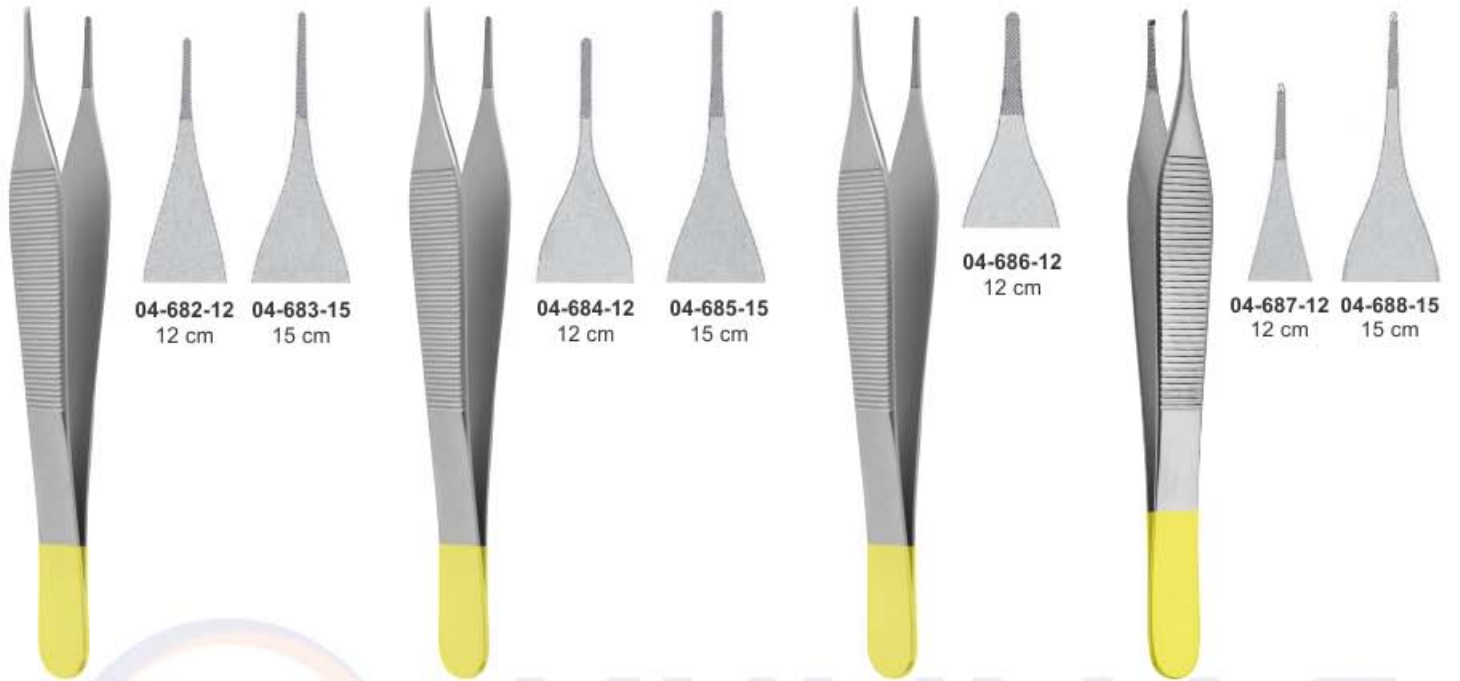

**Micro Adson**

**Adson**

**Adson**

**Micro Adson Tissue  
Forceps  
1x2 teeth**

**KUMMAS**  
CORPORATION

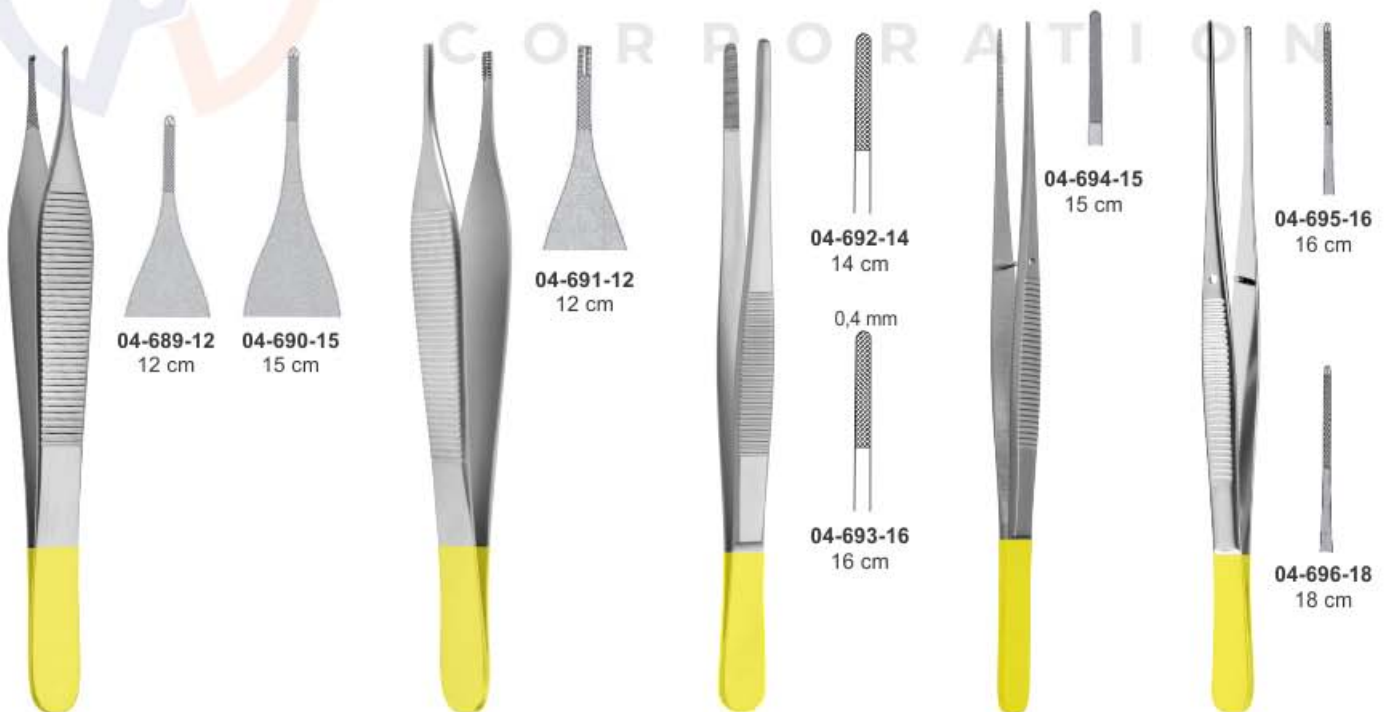

**Adson Tissue Forceps  
1x2 teeth**

**Adson Tissue Forceps  
3x4 teeth**

**Dressing Forceps  
Standard T.C**

**Semken Forceps T.C  
with dissector end**

**Semken  
Forceps T.C  
1x2 teeth**





**POTTS-SMITH  
Dressing Forceps T.C**  
04-697-15 15 cm  
04-698-18 18 cm  
04-699-20 20 cm  
04-700-23 23 cm  
04-701-25 25 cm



**Evans Dressing  
Forceps T.C**  
04-702-25  
25 cm



**Evans Pelvic Needle  
Dressing Forceps T.C**  
04-703-25 25 cm



**Cushing Forceps T.C**  
04-704-18 18 cm



**Cushing Dressing T.C  
Forceps**  
04-705-18  
18 cm Cross Serrated



**Cushing Dressing T.C  
Forceps**  
04-706-18 18 cm



**Mc Indoe Dressing  
Forceps T.C**  
04-707-15 15 cm



**Gillies Tissue  
Forceps T.C**  
04-708-15 15 cm



**De Bakey Dressing  
Forceps T.C**  
04-709-15 15 cm  
04-710-19 19 cm  
04-711-24 24 cm



**DeBakey Micro Needle  
Tissue Forceps T.C**  
04-712-18 18 cm



**Dissecting Tissue  
Forceps T.C**  
04-713-18 18 cm



- 04-714-14  
14 cm
- 04-715-16  
16 cm
- 04-716-18  
18 cm
- 04-717-20  
20 cm
- 04-718-25  
25 cm
- 04-719-30  
30 cm

Oshner Tissue  
Forceps T.C



Gerald Dissecting  
Forceps T.C  
04-720-17  
17.5 cm



Resano Dressing  
Forceps T.C  
04-721-25 25 cm



Cushing Dressing  
Forceps T.C  
04-722-19 19 cm

KUMMAS CORPORATION



Bonney Dissecting  
& Tissue Forceps T.C



04-723-18  
1x2 Teeth  
18 cm  
Straight  
X-Serrations



04-724-18  
1x2 Teeth  
18 cm  
Straight,  
Serrated



04-725-18  
2x3 Teeth  
18 cm  
Straight,  
Serrated



Wangensteen Dressing  
Forceps T.C.



04-726-15  
15.5 cm



04-727-23  
23 cm



04-728-25  
25.5 cm